



Automation for a Changing World

# Delta Temperature Controller DT Series



[www.deltaww.com](http://www.deltaww.com)

 **DELTA**  
Smarter. Greener. Together.

# Features

## Many Sizes Available:

- From 48x24 mm to 96x96 mm, all panel sizes comply with international standards

## Quality Assurance:

- All temperature controllers adopt an isolated switching power supply
- 100 ~ 240 V<sub>AC</sub> / 24 V<sub>DC</sub> input power supply applicable in all countries of the world
- CE, UL and C-Tick certified



## Supports Various Sensors:

- Various built-in sensor input modes: Thermocouple, platinum RTD or linear voltage/current

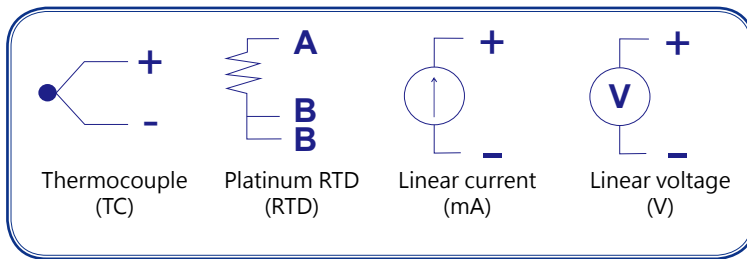

## Various Output Modes:

- Relay, voltage pulse, linear voltage, and linear current

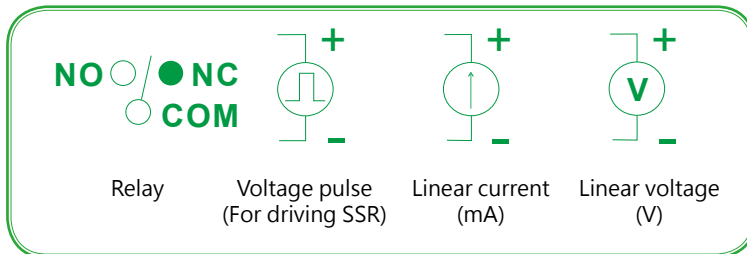

## Stable Control:

- Built-in PID control function, with accurate auto-tuning (AT).
- PID parameters are automatically calculated, enhancing the stability of the system and accuracy of control

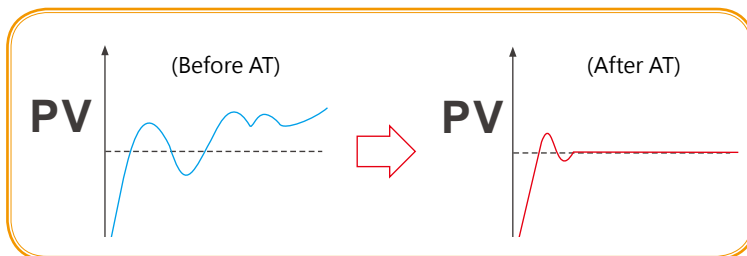

## Current Transformer (CT):

- CT can enable the off-line alarm and can detect if the current is overloaded





### Programmable Control:

- Max. 8 patterns available, with 8 steps in each pattern.  
No master controller is required for planning many kinds of temperature control curves

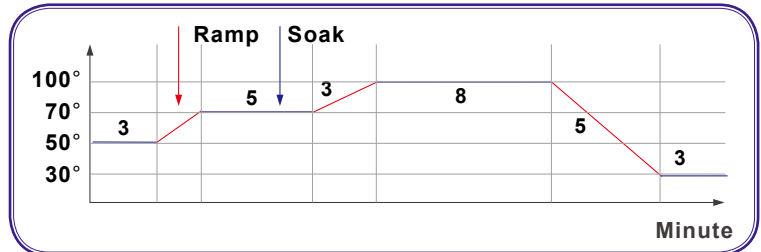

### Communication:

- RS-485 communication interface, supporting MODBUS ASCII/RTU communication

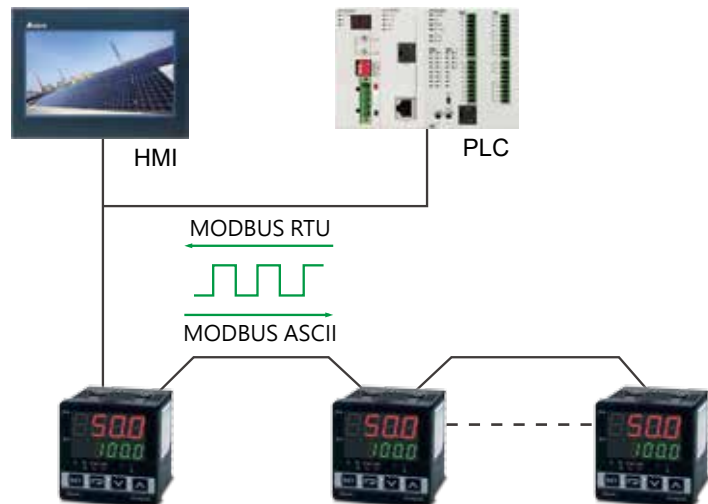

### Safety:

- The key-locking function and communication protection prevents malfunction



### Dual Output Control:

- Able to execute heating and cooling controls at the same time, allowing the system to reach the set temperature quickly

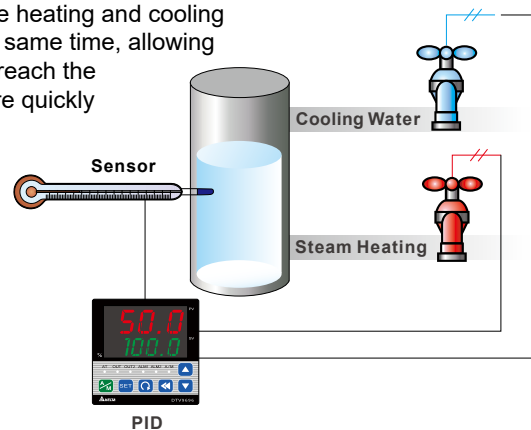

# Delta Temperature Controller DT Series

## Delta Multi-Loop Modular Temperature Controller DTM

Various input channel, multi-point temperature control, available in RS-485 Type and Ethernet Type



## Standard Temperature Controller DTA

Basic single channel input and output



## Advanced Temperature Controller DTB

Linear voltage control output and dual-loop control output



## Modular Temperature Controller DTC

Side-by-side modular design to monitor multi-points, flexible combination based on output requirements



## Valve Controller DTV

Suitable for DTV control applications, easy setting and built-in Modbus for efficient data collection



## Multi-Channel Modular Temperature Controller

Supports up to 8 sets of thermocouple or 6 sets of platinum RTD, multiple output modules available



## Advanced Intelligent Temperature Controller DT3

Modular design with various control modes and heater disconnection detection function, remote input



## Intelligent Temperature Controller DTK

Simple design with high-speed data collection for basic application



# Products

## DT3 High Speed Intelligent Temperature Controller

The Delta temperature controller DT3 series is designed with upgraded hardware and higher specifications as well as smart operation, fast response, easy modularization, plus user-friendly and user-defined function keys. With Self-Tuning and FUZZY temperature control functions, controllers can be installed in open space and confined space applications and are capable of presenting a smooth temperature control curve. In addition, the innovative design enables customers to replace the module with new functions to attain the ultimate in extension flexibility.



### Remote Control

Sets DT3 temperature via analog output of host controller

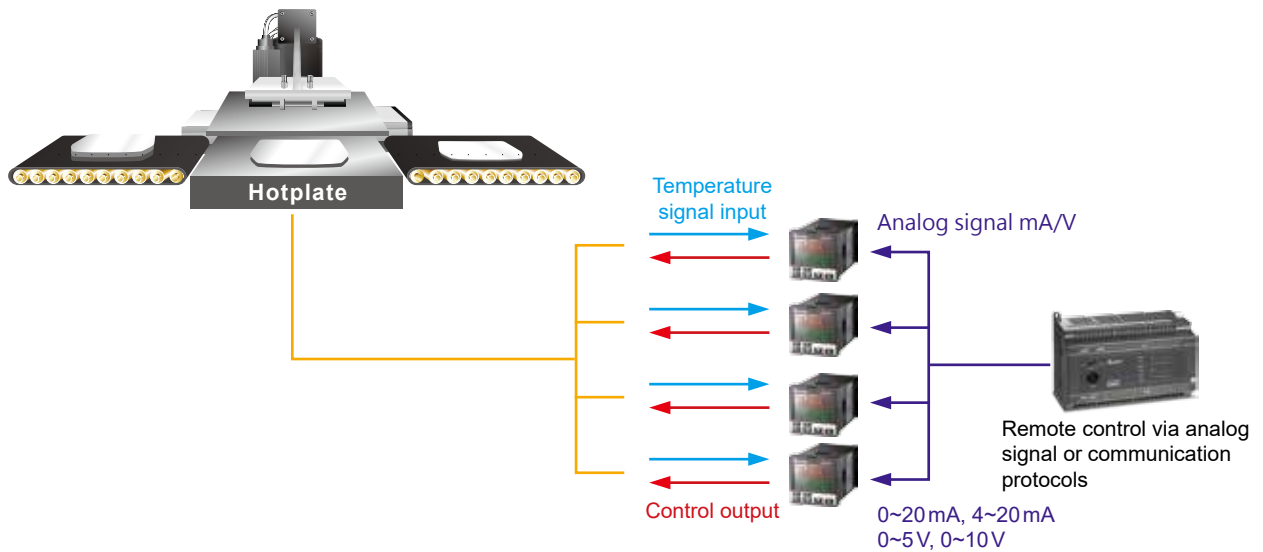

### Various Control Modes

- ▶ Auto Tuning
- ▶ FUZZY
- ▶ Manual
- ▶ ON/OFF
- ▶ PID Process Control
- ▶ Self Tuning

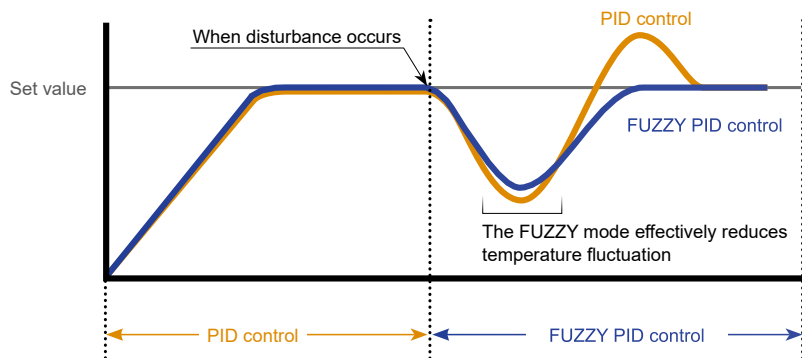

## ■ Extension Ability

Modular design of functional devices lets users replace the module as needed for application flexibility



## ■ Large Tri-color LCD Display

The 1<sup>st</sup> Tri-color LCD temperature controller in Taiwan.



## ■ Heater Disconnection Detection

Measurable up to 100A

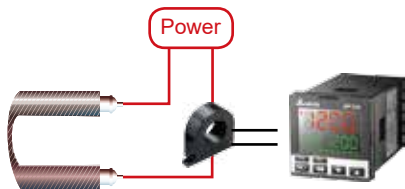

## ■ Retransmission Output

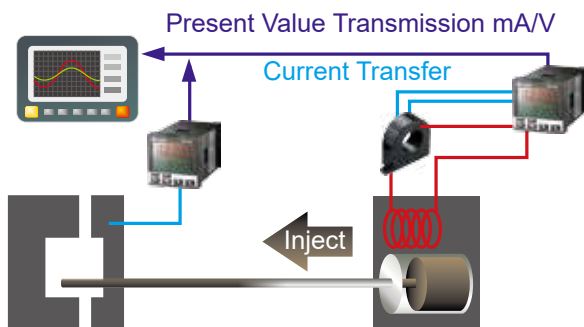

## ■ User-defined Function Keys

- ▶ Menu
- ▶ Auto-tuning
- ▶ Control modes selection
- ▶ RUN/STOP Mode
- ▶ Program hold



## ■ Point-to-point Control (Proportional Output mA/V)

Sets the Present Value by point-to-point control.



## ■ Dual Output Control

- ▶ Preset temperature is rapidly attained using two sets of outputs for heating and cooling control
- ▶ This function is used to automatically calculate two sets of PID parameters, one for heating and one for cooling

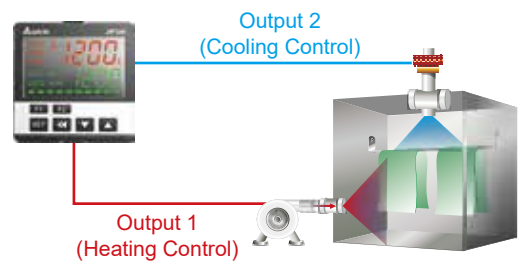

# Specifications

Input power supply	100 to 240V <sub>AC</sub> , 50/60Hz, 24V <sub>DC</sub> ±10%
Display method	LCD. Present Value: Orange, Set Value: green
Input sensors	Thermocouple: K, J, T, E, N, R, S, B, L, U, TXK
	Platinum RTD: Pt100, JPt100; RTD: Cu50, Ni120
	Analog input: 0 to 5 V, 0 to 10 V, 0 to 20 mA, 4 to 20 mA, 0 to 50 mV
Control modes	PID, PID programmable, FUZZY, Self-tuning, manual, ON/OFF
Display accuracy	0 or 1 digit to the right of the decimal point
Sampling rate	Analog input: 0.1s, Thermocouple or platinum RTD: 0.1s
Operating Ambient Temperature	0 ~ +50°C
Operating Relative Humidity	35 to 80% RH (non-condensing)

## Alarm Outputs

The DT3 offers 3 alarm outputs, and each alarm output has 18 alarm modes to choose from in the initial setting mode. When the target temperature exceeds or falls below the set point, the alarm output is enabled.

SV	Alarm Mode	Alarm Output Operation
0	Alarm function disabled	
1	Deviation upper- and lower-limit: This alarm output operates when PV value is higher than the set value SV + (AL - H) or lower than the set value SV - (AL - L).	
2	Deviation upper-limit: This alarm output operates when PV value is higher than the set value SV + (AL - H).	
3	Deviation lower-limit: This alarm output operates when PV value is lower than the set value SV - (AL - L).	
4	Absolute value upper- and lower-limit: This alarm output operates when PV value is higher than the set value AL-H or lower than the set value AL - L.	
5	Absolute value upper-limit: This alarm output operates when PV value is higher than the set value AL - H.	
6	Absolute value lower-limit: This alarm output operates when PV value is lower than the set value AL - L.	
7	Hysteresis upper-limit alarm output: This alarm output operates if PV value is higher than the set value SV + (AL - H). This alarm output is OFF when PV value is lower than the set value SV + (AL - L).	
8	Hysteresis lower-limit alarm output: This alarm output operates if PV value is lower than the set value SV - (AL - H). This alarm output is OFF when PV value is higher than the set value SV - (AL - L).	
9	Disconnection Alarm: This alarm output operates if the sensor connection is incorrect or has been disconnected.	
11	CT1 Alarm: CT1 is ON if the value of CT1 is lower than the value of AL - L or higher than AL - H.	
12	CT2 Alarm: CT2 is ON if the value of CT2 is lower than the value of AL - L or higher than AL - H.	
13	When SOAK status (temperature hold) happens to PID program control, alarm output is ON.	
14	When RAMP UP status happens to PID program control, alarm output is ON.	
15	When RAMP DOWN status happens to PID program control, alarm output is ON.	
16	When RUN status happens to PID program control, alarm output is ON.	
17	When HOLD status happens to PID program control, alarm output is ON.	
18	When STOP status happens to PID program control, alarm output is ON.	
19	When END status happens to PID program control, alarm output is ON.	

## RS-485 Communication

DT3 supports baudrate 2,400 to 38,400 bps, MODBUS ASCII/RTU protocol, function code 03H and reads maximum 8 words from the register.

Address	Content	Definition
1000H	Present value (PV)	Measuring unit: 0.1 scale. The following values read mean error occurs. 8002H: Temperature not yet acquired 8003H: Not connected to sensor 8004H: Incorrect sensor
1001H	Set value (SV)	Measuring unit: 0.1 scale
1002H	Upper limit of temp. range	Cannot exceed the default value
1003H	Lower limit of temp. range	Cannot fall below the default value
1005H	Control mode	0: PID, 1: ON/OFF, 2: Manual, 3: FUZZY
1006H	Heating/ Cooling control	0: Heating/Heating, 1: Cooling/Heating, 2: Heating/Cooling, 3: Cooling/Cooling
1007H	1 <sup>st</sup> Heating/ Cooling control cycle	0.1 ~ 99 sec.
1008H	2 <sup>nd</sup> Heating/ Cooling control cycle	0.1 ~ 99 sec.
1009H	Proportional band (PB)	0.1 ~ 999.9
100AH	Ti value	0 ~ 9999
100BH	Td value	0 ~ 9999
1012H	Read/write Output 1 volume	Unit: 0.1%, only valid in manual control mode
1013H	Read/write Output 2 volume	Unit: 0.1%, only valid in manual control mode
1016H	Regulated temp. value	-99.9 ~ +99.9, Unit: 0.1
102AH	Read/write LED status	b0: ALM3, b1: ALM2, b2: °F, b3: °C, b4: ALM1, b5: OUT2, b6: OUT1, b7 : AT
102BH	Read/write key status	b0: Set, b1: Select, b2: Up, b3: Down, 0: Press it
102CH	Panel lockup status	0: Normal, 1: Fully locked, 11: SV adjustable
102DH	CT value	Unit: 0.1A
103BH	AT setting	0: OFF (default), 1: ON
103CH	Control RUN/STOP setting	0: STOP, 1: RUN (default), 2: END (program), 3: HOLD (program)





# Parameters Operation

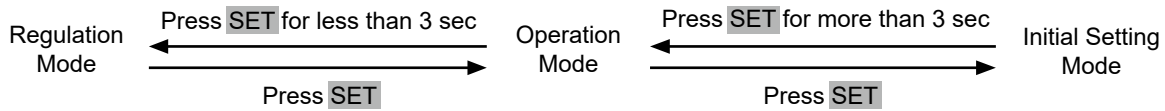

Regulation Mode	Operation Mode	Initial Setting Mode
<b>AL</b> Auto-tuning (when CTRL set in PID or FUZZY and in RUN mode) Press ◀ ▽	<b>T34</b> Use ▲ ▼ to set up target temperature Press ◀ ▽	<b>INPE</b> Set up input type Press ◀ ▽
<b>SE</b> Self-tuning switch (set when in PID control and the TUNE parameter = ST)	<b>R-S</b> Control loop RUN or STOP	<b>EPUN</b> Set up temperature unit (not displayed when in analog input)
<b>PcD</b> Select the nth (n = 0 ~ 5) PID. When n = 6, PID is auto-selected.	<b>PERN</b> Set up start pattern (when in PID programmable control and <b>PSLP</b> )	<b>EP-H</b> Set up upper temperature limit
<b>Pdof</b> Set up PID control offset	<b>SEEP</b> Set up start step (when in programmable control)	<b>EP-L</b> Set up lower temperature limit
<b>FZ-R</b> Set up FUZZY gain value	<b>SP</b> Set up the position of decimal point	<b>CTRL</b> Select control modes
<b>FZdb</b> Set up FUZZY Deadband	<b>LoL</b> Lock the keys	<b>CTRLS</b> Select SV control modes
<b>o1-S</b> Adjust Output 1 hysteresis (when in ON/OFF control)	<b>AL1H</b> Set up upper limit of Alarm 1	<b>WESV</b> Set up waiting temperature (when in programmable control)
<b>o2-S</b> Adjust Output 2 hysteresis (when in ON/OFF control)	<b>AL1L</b> Set up lower limit of Alarm 1	<b>W-EN</b> Set up waiting time (when in programmable control)
<b>o1-H</b> <b>o1-L</b> Control cycle for Output 1 (except in ON/OFF control)	<b>AL2H</b> Set up upper limit of Alarm 2	<b>SLoP</b> Set up start slope (when in programmable control)
<b>o2-H</b> <b>o2-L</b> Control cycle for Output 2 (except in ON/OFF control)	<b>AL2L</b> Set up lower limit of Alarm 2	<b>PR-EN</b> Select pattern to be edited
<b>CoEF</b> Ratio of Output 1 against Output 2 when in dual output control (set when in PID and dual output control)	<b>AL3H</b> Set up upper limit of Alarm 3	<b>EUNE</b> Select AT or ST
<b>dEAd</b> Set up deadband (when in dual output)	<b>AL3L</b> Set up lower limit of Alarm 3	<b>S-HC</b> Select heating, cooling or dual output heating and cooling
<b>PV-F</b> Set up input filter factor	<b>AL1HP</b> Record highest temperature of Alarm 1	<b>AL1A</b> <b>AL2A</b> <b>AL3A</b> Set up Alarm 1 mode
<b>PV-R</b> Set up input filter range	<b>AL1LP</b> Record lowest temperature of Alarm 1	<b>AL1o</b> <b>AL2o</b> <b>AL3o</b> Set up Alarm 1 options
<b>PVoF</b> Adjust input compensation	<b>AL2HP</b> Record highest temperature of Alarm 2	<b>AL1d</b> <b>AL2d</b> <b>AL3d</b> Set up Alarm 1 delay
<b>PVGR</b> Adjust input gain	<b>AL2LP</b> Record lowest temperature of Alarm 2	<b>o-EN</b> Set up reverse alarm output
<b>SUSL</b> Set up rising slope (when CRTS = SLOP)	<b>AL3HP</b> Record highest temperature of Alarm 3	<b>RMEF</b> Set up Remote type
<b>ALMR</b> Adjust upper limit compensation for analog Output 1*	<b>AL3LP</b> Record lowest temperature of Alarm 3	<b>EXEC</b> Select auxiliary function

Regulation Mode	Operation Mode	Initial Setting Mode
<b>RLM1</b> Adjust lower limit compensation for analog Output 1*	<b>oUL1</b> Display and adjust Output 1 volume	<b>CoSH</b> Enable/disable communication write-in
<b>RLM2</b> Adjust upper limit compensation for analog Output 2*	<b>oUL2</b> Display and adjust Output 2 volume	<b>C-SL</b> Select ASCII or RTU format
<b>RLM1</b> Adjust lower limit compensation for analog Output 2*	<b>oLMA</b> Set up upper limit percentage for Output 1	<b>C-Ad</b> Set up communication address
<b>RLM2</b> Adjust upper limit compensation for Retransmission*	<b>oLM1</b> Set up lower limit percentage for Output 1	<b>bPS</b> Set up baudrate
<b>RLM1</b> Adjust lower limit compensation for Retransmission*	<b>o2MR</b> Set up upper limit percentage for Output 2	<b>LEN</b> Set up data length
<b>RM-6</b> Adjust Remote gain	<b>o2ML</b> Set up lower limit percentage for Output 2	<b>StoP</b> Set up stop bit
<b>RM-F</b> Adjust Remote compensation	<b>CL1</b> Display current measured at CT1	<b>PRLY</b> Set up parity bit
<b>EVt1</b> Set up EVENT1 function	<b>CL2</b> Display current measured at CT2  Press ◀ to return to set up target temperature	Press ◀ to return to set up input type
<b>EVt2</b> Set up EVENT2 function		
<b>EVt3</b> Set up EVENT3 function Press ◀ to return to auto-tuning		

\*1 scale = 2μA; 1 scale = 1mV

PID mode: Any of the 6 PID groups can be selected. When n = 6, the program will automatically select the PID group that is the closest to the target temperature.

<b>PcD</b> Select the nth PID (n = 0 ~ 5)  Press ◀ ▷ 0 ~ 5 <sup>th</sup> PID	<b>SP0</b> Set up the 0 <sup>th</sup> PID temperature value Press ◀ ▽	<b>SP5</b> Set up the 5 <sup>th</sup> PID temperature value Press ◀ ▽
	<b>P0</b> Set up the 0 <sup>th</sup> proportional band value	<b>P5</b> Set up the 5 <sup>th</sup> proportional band value
	<b>T0</b> Set up the 0 <sup>th</sup> Ti value	<b>T5</b> Set up the 5 <sup>th</sup> Ti value
	<b>d0</b> Set up the 0 <sup>th</sup> Td value	<b>d5</b> Set up the 5 <sup>th</sup> Td value
	<b>CoFD</b> Set up the 0 <sup>th</sup> PID integral deviation Press ◀ to return to PID deviation	<b>CoFS</b> Set up the 5 <sup>th</sup> PID integral deviation Press ◀ to return to PID deviation

Patterns and steps: Edit **PRoB** in **CLRL** parameter. Take editing pattern 0 for example:

<b>PLRM</b> Select the pattern number to be edited Select number ▷ Press ◀ ▽ to select OFF	<b>SP00</b> Edit temperature for Step 0 Press ◀ ▽	<b>PSY0</b> Select actual number of steps when the program is executing Press ◀ ▽
Exit pattern and step editing and switch to <b>S-HC</b> to continue the setup process	<b>EM00</b> Edit time for Step 0 (time unit: hr, min)	<b>CYCO</b> Set up additional cycles (0 ~ 99) for the pattern execution
	Set up Step 0 ~ 15 in order	<b>LCND</b> Set up link pattern. OFF refers to the program end. Press ◀ to return to select the pattern number to be edited
	<b>SP15</b> Edit temperature for Step 15 <b>tM15</b> Edit time for Step 15 Press ◀ to set up actual step numbers	

## Products

# DTK

## New generation of intelligent temperature controller

DTK Series is a new temperature controller with a high cost-performance ratio. It greatly decreases development costs and time, and improves the functions of temperature control systems. With a length of only 60mm and high resolution LCD display, it is easy for operators to monitor the temperatures of any environment or occasion.



## Features

- ▶ High resolution LCD display
- ▶ Length shortened to 60 mm
- ▶ High speed sampling time 100 ms
- ▶ CE certified, UL

## Description



- A** PV : Present Value
- B** SV : Set Value
- C** °C、°F : Celsius , Fahrenheit temperature indicator
- D** 1、2 : ALM1 , ALM2 alarm output indicator
- E** A/M : Auto-tuning and manual modes indicator
- F** OUT1、OUT2 : Output indicator
- G** Select / Set key
- H** Value adjustment key

## Electrical Specifications

<b>Power supply</b>	100 ~ 240 V <sub>AC</sub> , 50/60 Hz
<b>Display</b>	LCD display. PV : red, SV : green
<b>Input temperature sensors</b>	Thermocouple : K, J, T, E, N, R, S, B, L, U, TXK
	Platinum RTD : Pt100, JPt100
	RTD : Cu50, Ni120
<b>Control methods</b>	ON/OFF, PID, Manual
<b>Display scale</b>	1 digit after decimal point, or no decimal point
<b>Sampling rate</b>	Thermocouple or platinum RTD : 0.1 second
<b>Ambient temperature</b>	0 ~ +50 °C
<b>Ambient humidity</b>	35 ~ 80% RH (non-condensing)

## Alarm Outputs

The DTK Series offers 2 alarm outputs, and each alarm output has 9 alarm modes to choose from in the initial setting mode. When the target temperature exceeds or falls below the set point, the alarm output is enabled.

SV	Alarm Mode	Alarm Output Operation
0	Alarm function disabled	
1	Deviation upper- and lower-limit : This alarm output operates when PV value is higher than the set value SV + (AL - H) or lower than the set value SV - (AL - L).	
2	Deviation upper-limit : This alarm output operates when PV value is higher than the set value SV + (AL - H).	
3	Deviation lower-limit : This alarm output operates when PV value is lower than the set value SV - (AL - L).	
4	Absolute value upper- and lower-limit : This alarm output operates when PV value is higher than the set value AL - H or lower than the set value AL - L.	
5	Absolute value upper-limit : This alarm output operates when PV value is higher than the set value AL - H.	
6	Absolute value lower-limit : This alarm output operates when PV value is lower than the set value AL - L.	
7	Hysteresis upper-limit alarm output : This alarm output operates if PV value is higher than the set value SV+ (AL - H). This alarm output is OFF when PV value is lower than the set value SV + (AL - L).	
8	Hysteresis lower-limit alarm output : This alarm output operates if PV value is lower than the set value SV - (AL - H). This alarm output is OFF when PV value is higher than the set value SV - (AL - L).	
9	Disconnection alarm : This alarm output operates if the sensor connection is incorrect or has been disconnected.	

# Parameters Operation

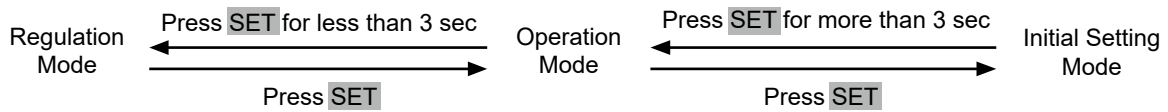

Regulation Mode	Operation Mode	Initial Setting Mode
<b>RL</b> Auto - tuning ( when in PID control and RUN mode ) Press  ▾	<b>1234</b> Use ▲ ▼ to set up target temperature Press  ▾	<b>Ctrl</b> Set up input type Press  ▾
<b>P</b> Set proportion band	<b>r-S</b> Control loop RUN or STOP	<b>EPUn</b> Set up temperature unit
<b>I</b> Set integration time	<b>SP</b> Set up the position of decimal point	<b>EP-H</b> Set up upper temperature limit
<b>d</b> Set derivative time	<b>LoC</b> Lock the keys	<b>EP-L</b> Set up lower temperature limit
<b>Pdof</b> Set up PID control offset	<b>RLIH</b> Set up upper limit of Alarm 1	<b>Ctrl</b> Select control modes
<b>o1-S</b> Adjust Output 1 hysteresis (when in ON / OFF control)	<b>RLIL</b> Set up lower limit of Alarm 1	<b>S-HC</b> Select heating, cooling or dual output heating and cooling
<b>o2-S</b> Adjust Output 2 hysteresis (when in ON / OFF control)	<b>RL2H</b> Set up upper limit of Alarm 2	<b>RLR1</b> Set up Alarm 1 mode
<b>o1-H</b> OUT1 HEAT: Heating control cycle for Output 1 (when Ctrl = PID/FUZZY/MANUAL)	<b>RL2L</b> Set up lower limit of Alarm 2	<b>RLIo</b> Set up Alarm 1 options *3
<b>o1-C</b> OUT1 COOL: Cooling control cycle for Output 1 (when Ctrl = PID/FUZZY/MANUAL)	<b>oUe1</b> Display and adjust Output 1 volume	<b>RLId</b> Set up Alarm 1 delay *4
<b>o2-H</b> OUT2 HEAT: Heating control cycle for Output 2 (when Ctrl = PID/FUZZY/MANUAL)	<b>oUe2</b> Display and adjust Output 2 volume	<b>RLR2</b> Set up Alarm 2 mode
<b>o2-C</b> OUT2 COOL: Cooling control cycle for Output 2 (when Ctrl = PID/FUZZY/MANUAL)	<b>o1nR</b> Set up upper limit percentage for Output 1	<b>RL2o</b> Set up Alarm 2 options *3
<b>CoEF</b> Ratio of Output 1 against Output 2 when in dual output control (set when in PID control)	<b>o1nc</b> Set up lower limit percentage for Output 1	<b>RL2d</b> Set up Alarm 2 delay *4
<b>dERd</b> Set up deadband	<b>o2nR</b> Set up upper limit percentage for Output 2	
<b>Pu-F</b> Set up input filter factor	<b>o2nc</b> Set up lower limit percentage for Output 2	
<b>Pu-r</b> Set up input filter range		
<b>Puof</b> Adjust input compensation *1		
<b>PuGR</b> Adjust input gain *1		
<b>RLnR</b> Adjust upper limit compensation for analog Output 1 *2		
<b>RLnc</b> Adjust lower limit compensation for analog Output 1 *2 Press  to return to auto-tuning	Press  to return to set up target temperature	Press  to return to set up input type

## Parameters Operation

- \* Alarm 1 is automatically switched to output control 2 when selecting dual output mode
- \* Set up upper / lower limit percentage for output 1 / 2 volume : set output permission ranges. E.g. upper and lower limit percentage are respectively set as 90 and 20, output volume will be limited to 20% ~ 90%.
- \*1. Offset Present value : Use  $P_{\text{offset}}$  and  $P_{\text{offsetR}}$ .  
Present value = measured value  $\times (1 + P_{\text{offsetR}}/1.000) + P_{\text{offset}}$ .
- \*2. 1 scale = 1 $\mu$ A
- \*3. Set up alarm standby : set corresponding Y value as xxxY (Y = 0 : normal / Y = 1 : standby)  
Set up reverse alarm output : set corresponding Y value as xxYx (Y = 0 : forward / Y = 1 : backward)  
Set up Hold output : set corresponding Y value as xYxx (Y = 0 : normal / Y = 1 : Hold)
- \*4. Set up alarm delay : The alarm operates after reaching alarm delay time (recalculating time if discontinuity occurs in the process)

## Temperature Sensors and Temperature Range

Input sensors	Display	Temperature Range	Input sensors	Display	Temperature Range
Platinum RTD: Pt100	PE	-200 ~ 850°C	Thermocouple E	E	0 ~ 600°C
Platinum RTD: JPt100	JPE	-100 ~ 400°C	Thermocouple T	T	-200 ~ 400°C
Copper resistance: Cu50	EU	-50 ~ 150°C	Thermocouple J	J	-100 ~ 850°C
RTD Ni120	nL	-80~300°C	Thermocouple K	K	-200 ~ 1,300°C
Thermocouple B	b	100 ~ 1,800°C	Thermocouple L	L	-200 ~ 850°C
Thermocouple S	S	0 ~ 1,700°C	Thermocouple U	U	-200 ~ 500°C
Thermocouple R	r	0 ~ 1,700°C	Thermocouple Txk	TXK	-200 ~ 800°C
Thermocouple N	n	-200 ~ 1,300°C			

## Panel Sizes

Models	Sizes (W × H)
4848	45 mm × 45 mm
4896	44.5 mm × 91.5 mm
7272	68 mm × 68 mm
9696	91.5 mm × 91.5 mm

## Terminal Wiring Diagram

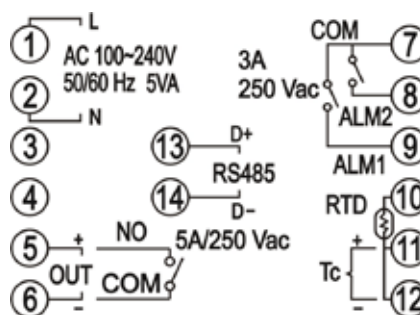

## Products

# DTA Standard Type

DTA is designed for practical applications, offering the 3 most frequently adopted output types in the market. DTA has many user-friendly functions built-in and a handy transmission structure, ensuring fast and stable data transmission.

Optional functions: RS-485 communication interface (MODBUS ASCII/RTU, 2,400 ~ 38,400 bps), CT (current transformer)



## Electrical Specifications

Power supply	100 ~ 240 V <sub>AC</sub> , 50/60Hz
Voltage range	85 ~ 110% rated voltage
Power consumption	5VA Max.
Display	2-line 7-segment LED display, PV: red; SV: green
Input temperature sensors	Thermocouple: K, J, T, E, N, R, S, B, U, L, TXK
	Platinum RTD: Pt100, JPt100
Display scale	1 digit after decimal point, or no decimal point
Control methods	PID, ON/OFF, Manual
Output types	Relay: 250 V <sub>AC</sub> , 5A, SPDT (DTA4848: SPST)
	Voltage pulse: 14 V <sub>DC</sub> , Max. output current: 40 mA
	Current: DC 4 ~ 20 mA (Load resistance: < 600 Ω)
Sampling rate	0.5 second
Communication	RS-485 digital communication, 2,400 ~ 38,400 bps (optional)
Communication protocol	MODBUS protocol, ASCII/RTU format (optional)
Vibration resistance	10 ~ 55Hz, 10 m/s <sup>2</sup> for 10 mins in X, Y, Z direction
Shock resistance	Max. 300 m/s <sup>2</sup> , 3 times in each of 3 axes, 6 directions
Ambient temperature	0 °C ~ 50 °C
Storage temperature	-20 °C ~ +65 °C
Altitude	< 2,000 m
Ambient humidity	35 ~ 85% RH (non-condensing)
IP Rating (Panel)	IP65

## Products

# DTB Advanced Type

Compared to the DTA, DTB has an added linear voltage output and adopts dual-loop output control, and is able to execute heating and cooling controls at the same time in a temperature control system.

DTB series has a built-in RS-485 communication interface (MODBUS ASCII/RTU, 2,400 ~ 38,400bps). The programmable PID control function allows the DTB to set up 64 sets of temperature and control times.

Optional functions:

- CT (current transformer), output by alarm.
- EVENT function, switching between 2 SVs by using PLC or switches.
- Valve models are able to adjust the action level of valves depending on the SV.



## Electrical Specifications

Power supply	100 ~ 240 V <sub>AC</sub> , 50/60 Hz; 24 V <sub>DC</sub> ± 10 %
Voltage range	85 ~ 110% rated voltage
Power consumption	< 5 VA
Display	2-line 7-segment LED display, 4 digits available, PV: red, SV: green
Input temperature sensors	Thermocouple: K, J, T, E, N, R, S, B, L, U, TXK
	Platinum RTD: Pt100, JPt100
	Analog input: 0 ~ 5V, 0 ~ 10V, 0 ~ 20mA, 4 ~ 20mA, 0 ~ 50mV
Display scale	1 digit after decimal point, or no decimal point
Control methods	PID, programmable PID, ON/OFF, Manual
Output types	Relay: SPDT (DTB4848/4824: SPST), Max. load: 250 V <sub>AC</sub> , Resistive load: 5A
	Voltage pulse: 14 V <sub>DC</sub> , Max. output current: 40 mA
	Current: DC 4 ~ 20 mA (Load resistance: < 600 Ω)
	Analog voltage: 0 ~ 10V
Sampling rate	Analog input: 0.15 second, Thermocouple or platinum RTD: 0.4 second
Communication	RS-485 digital communication, 2,400 ~ 38,400bps
Communication protocol	MODBUS protocol, ASCII/RTU format
Vibration resistance	10 ~ 55Hz, 10 m/s <sup>2</sup> for 10 mins in X, Y, Z direction
Shock resistance	Max. 300 m/s <sup>2</sup> , 3 times in each of 3 axes, 6 directions
Ambient temperature	0°C ~ 50°C
Storage temperature	-20°C ~ +65°C
Altitude	< 2,000 m
Ambient humidity	35 ~ 85% RH (non-condensing)
IP Rating (Panel)	IP65



# DTC Modular Type

DTC features a modular and wire-saving structure, and is able to monitor many temperature points by parallel and modular extension. The user is able to set up a suitable output method according to actual demand. The built-in password protection prevents unauthorized operation or malicious damage from staff.

DTC series has a built-in RS-485 communication interface (MODBUS ASCII/RTU, 2,400 ~ 38,400bps). The programmable PID control function allows the DTC to set up 64 sets of temperature and control times. DTC also supports 3 levels of password protection, synchronous communication protocol and auto ID setup.



## Electrical Specifications

Power supply	24 V <sub>DC</sub> , isolated switching power supply
Voltage range	90 ~ 110% rated voltage
Power consumption	3 W + 3 W x number of DTC2000 controllers connected in parallel (Max. 7)
Input temperature sensors	Thermocouple: K, J, T, E, N, R, S, B, L, U, TXK
	Platinum RTD: Pt100, JPt100
	Analog input: 0 ~ 5V, 0 ~ 10V, 0 ~ 20mA, 4 ~ 20mA, 0 ~ 50mV
Control methods	PID, programmable PID, ON/OFF, Manual
Output types	Relay: SPST, Max. load: 250 V <sub>AC</sub> , Resistive load: 3A
	Voltage pulse: 12 V <sub>DC</sub> , Max. output current: 40 mA
	Current: DC 4 ~ 20 mA (Load resistance: < 500 Ω)
	Analog voltage: 0 ~ 10 V (Load resistance: > 1,000 Ω)
Sampling rate	Analog input: 0.15 second, Thermocouple or platinum RTD: 0.4 second
Communication	RS-485 digital communication, 2,400 ~ 38,400 bps
Communication protocol	MODBUS protocol, ASCII/RTU format
Vibration resistance	10 ~ 55 Hz, 10 m/s <sup>2</sup> for 10 mins in X, Y, Z direction
Shock resistance	Max. 300 m/s <sup>2</sup> , 3 times in each of 3 axes, 6 directions
Ambient temperature	0 °C ~ 50 °C
Storage temperature	-20 °C ~ +65 °C
Altitude	< 2,000 m
Ambient humidity	35 ~ 85% RH (non-condensing)

## Products

# DTE Multi-Channel Modular Type

DTE series is a multi-channel modular type temperature controller. The DTE10T supports 8 thermocouple inputs and the DTE10P supports 6 platinum RTD inputs. The DTE series is installed on DIN rail, and each channel operates independently. DTE series offers many optional output modules (relay, voltage pulse, current and linear current). The built-in RS-485 2-wire communication allows transmission of up to 115,200 bps.



The programmable PID control function allows the DTE to set up 64 sets of temperature and control times. Maximum 7 DTC2000 controllers are extendable to DTE, and DTE supports the same synchronous communication protocol and auto ID setup which DTC supports.

## Electrical Specifications

Power supply	24 V <sub>DC</sub> , isolated switching power supply
Voltage range	90 ~ 110% rated voltage
Power consumption	Max. 10W + 3W x number of DTC2000 controllers connected in parallel (Max. 7)
Input temperature sensors	Thermocouple: K, J, T, E, N, R, S, B, L, U, TXK
	Platinum RTD: Pt100, JPt100 RTD: Cu50; Ni120
Control methods	PID, programmable PID, ON/OFF, Manual
Output types	Relay: SPST, Max. load: 250 V <sub>AC</sub> , Resistive load: 3A
	Voltage pulse: 12 V <sub>DC</sub> , Max. output current: 40 mA
	Current: DC 4 ~ 20 mA (Load resistance: < 500 Ω)
	Analog voltage: 0 ~ 10 V (Load resistance: > 1,000 Ω)
Sampling rate	Thermocouple or platinum RTD: 1.0 second/all inputs
Communication	RS-485 digital communication, 2,400 ~ 115,200 bps
Communication protocol	MODBUS protocol, ASCII/RTU format
Vibration resistance	10 ~ 55 Hz, 10 m/s <sup>2</sup> for 10 mins in X, Y, Z direction
Shock resistance	Max. 300 m/s <sup>2</sup> , 3 times in each of 3 axes, 6 directions
Ambient temperature	0 °C ~ 50 °C
Storage temperature	-20 °C ~ +65 °C
Altitude	< 2,000 m
Ambient humidity	35 ~ 85% RH (non-condensing)

# DTV **Valve Type**

DTV series is designed for electronic valve applications. It is user-friendly and easy to use. DTV has built-in MODBUS communication, which allows handier data collection.

DTV also features:

- Auto/manual mode switching by a single key
- "Left" key makes the parameter setting faster
- Real-time output percentage display, for the user to check the action level of the valve
- 2 alarm outputs, 17 alarm modes
- RS-485 communication interface for DTV to monitor and collect data from other temperature controllers on the network



## Electrical Specifications

Power supply	100 ~ 240 V <sub>AC</sub> , 50/60 Hz
Voltage range	85 ~ 110% rated voltage
Power consumption	< 5 VA
Display	2-line 7-segment LED display, 4-bit or 2-bit valve action level display available
	PV: red, SV & action level of valve: green
Input temperature sensors	Thermocouple: K, J, T, E, N, R, S, B, L, U, TXK
	Platinum RTD: Pt100, JPt100
	Analog input: 0 ~ 5 V, 0 ~ 10V, 0 ~ 20 mA, 4 ~ 20 mA, 0 ~ 50 mA
Display scale	1 digit after decimal point, or no decimal point
Control methods	PID, programmable PID, ON/OFF, Manual
Output types	Relay: SPST, Max. load: 250 V <sub>AC</sub> ; resistive load: 5A
	Current: DC 4 ~ 20 mA
Sampling rate	Analog input: 0.15 second; thermocouple or platinum RTD: 0.4 second
Communication	RS-485 digital communication, 2,400 ~ 38,400 bps
Communication protocol	MODBUS protocol, ASCII/RTU format
Vibration resistance	10 ~ 55 Hz, 10 m/s <sup>2</sup> for 10 mins in X, Y, Z direction
Shock resistance	Max. 300 m/s <sup>2</sup> , 3 times in each of 3 axes, 6 directions
Ambient temperature	0°C ~ 50°C
Storage temperature	-20°C ~ +65°C
Altitude	< 2,000 m
Ambient humidity	35 ~ 85% RH (non-condensing)
IP Rating (Panel)	IP65

# Ordering Information

## DT3

1 2 3 4 5 6 7 8

Series Name		Delta DT3 Series Temperature Controller	
1 2	Panel size (W x H)	20: 4848: 1/16 DIN W48 x H48 mm 30: 7272: W72 x H72 mm	40: 4896: 1/8 DIN W48 x H96 mm 60: 9696: 1/4 DIN W96 x H96 mm
3	Output 1 options	R: Relay, 250 V <sub>AC</sub> , 5 A V: Voltage pulse, 12V +10 to 20%	C: DC current, 4 to 20mA L: Linear voltage, 0 to 10 V <sub>DC</sub>
4	Power supply	A: AC 100 to 240 V D: DC 24 V	
5	Output 2 options	R: Relay, 250 V <sub>AC</sub> , 5 A V: Voltage pulse, 12V +10 to 20%	C: DC current, 4 to 20 mA L: Linear voltage, 0 to 10 V <sub>DC</sub>
6	Optional function 1	0: None, 1: Event input 3, 2: RS-485 communication	
7	Optional function 2	0: None, 1: Event input 2, 2: CT input 2, 3: Retransmission output	
8	Optional function 3	0: None, 1: Event input 1, 2: CT input 1, 3: Remote setup input	

## DT3 Accessories

D T 3 - 1

Accessories		Delta DT3 Series Temperature Controller	
1	Option 1	20ESTD: DT320 EXTENSION without RS-485 & EV3	R: Relay Output
		20ECOM: DT320 EXTENSION include RS-485	V: DC Voltage Pulse Output
		20EEV3: DT320 EXTENSION include EVENT3	C: DC Current Output
		40ESTD: DT340/DT360 EXTENSION without RS-485 & EV3	L: DC Linear Voltage Output
		40ECOM: DT340/360 EXTENSION include RS-485	EVENT: Event Input
		40EEV3: DT340/360 EXTENSION include EVENT3	CTI: CT Input
		DT330 is a replacement for DTA7272 (with basic function). It has less extension function. <ul style="list-style-type: none"> <li>DT330 □ A-0 has 1 output, 1 alarm output, and has no extension functions</li> <li>DT330 □ A has 1 output, 2 alarm outputs, but no extension functions (similar to DTA7272 □ 0)</li> <li>DT330 □ A-0200 has 1 output, 2 alarm outputs, and has no extension functions. It supports RS-485 communication function (similar to DTA7272 □ 1)</li> </ul>	
		REMOTE: Remote set point	
		CT30A: 30A CT	
		CT100A: 100A CT	



# DTK

1 2 3 4 5 6 7

Series Name		Delta DTK Series Temperature Controller	
1 2 3 4	Panel size (W x H)	4848: W48 × H48 mm 4896: W48 × H96 mm	7272: W72 × H72 mm 9696: W96 × H96 mm
5	Output options	R: Relay, 250 V <sub>AC</sub> , 5 A V: Voltage Pulse, 12 V <sub>DC</sub> +10~20%	C: DC Current Output 4 ~ 20mA
6	Optional function	0: N/A	1: RS-485 communication
7	Optional function	1: 1 Alarm output	2: 2 Alarm outputs

# DTA

1 2 3 4 5 6 - 7

Series Name		Delta DTA Series Temperature Controller	
1 2 3 4	Panel size (W x H)	4848: 1/16 DIN W48 x H48 mm 4896: 1/8 DIN W48 x H96 mm 9696: 1/4 DIN W96 x H96 mm	7272: W72 x H72 mm 9648: W96 x H48 mm
5	Output	R: Relay, SPST (4848: SPST), 250 V <sub>AC</sub> , 5 A V: Voltage pulse, 14V +10% ~ -20% (Max. 40mA)	C: Current, 4~20mA
6	Communication (optional)	0: N/A	1: RS-485 communication
7	CT (optional)	<input type="checkbox"/> : N/A	T: With CT (only DTA7272R0)

# DTB

1 2 3 4 5 6 7

\*DTB4824 has no optional function and no extra alarm output. Output 2 can be set to alarm output.  
\*DTB4848 has only 1 optional alarm output. Output 2 can be set to the 2<sup>nd</sup> alarm output.  
\*DTB9696 has optional valve control function. Model name: DTB9696RRV.

Series Name		Delta DTB Series Temperature Controller	
1 2 3 4	Panel size (W x H)	4824: 1/32 DIN W48 x H24 mm 4848: 1/16 DIN W48 x H48 mm	4896: 1/8 DIN W48 x H96 mm 9696: 1/4 DIN W96 x H96 mm
5	Output 1 options	R: Relay, SPDT (4824/4848: SPST), 250 V <sub>AC</sub> , 5A V: Voltage pulse: 14V +10% ~ -20% C: DC current: 4 ~ 20mA L: Linear voltage: 0 ~ 5V, 0 ~ 10 V <sub>DC</sub>	
6	Output 2 options	R: Relay, SPDT (4824/4848: SPST), 250 V <sub>AC</sub> , 5A V: Voltage pulse: 14V +10% ~ -20%	
7	Optional function	<input type="checkbox"/> : Without CT, without EVENT input T: With CT, without EVENT input	E: Without CT, with EVENT input V: Valve control



## DTC

1 2 3 4 5

Series Name		Delta DTC Series Temperature Controller
1	Controller type	1: Main unit 2: Extension unit
2	Number of auxiliary outputs	0: Standard 2 outputs, no auxiliary output
3 4	Optional function	00: Standard function 01: With CT input
5	Output	R: Relay, SPST, 250 V <sub>AC</sub> , 3A V: Voltage pulse, 12V +10% ~ -20% C: Current, 4 ~ 20mA L: Linear voltage, 0 ~ 10V

## DTE

1 2 3

Series Name		Delta DTE Series Temperature Controller
1	Controller type	1: Main unit 2: Accessory
2 3	Optional function	0T: 4-channel TC (main unit, accessory)      0R: 4 channels of relay output 0P: 3-channel PT (main unit, accessory)      0L: 4 channels of linear voltage output 0V: 4 channels of voltage pulse output      0D: 4 digital inputs & 4 digital outputs 0C: 4 channels of linear current output      CT: 4 channels of current transformers DS: Display & setup module

## DTV

1 2 3 4 5

Series Name		Delta DTV Series Temperature Controller
1 2 3 4	Panel size (W x H)	4896: 1/8 DIN W48 x H96 mm 9696: 1/4 DIN W96 x H96 mm
5	Output	R: Relay, SPDT, 250 V <sub>AC</sub> , 5A C: DC current: 4 ~ 20mA



# Dimensions

## DTB

4824

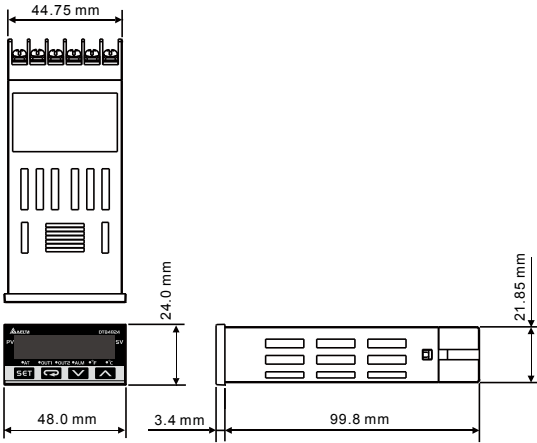

4848

Unit: mm

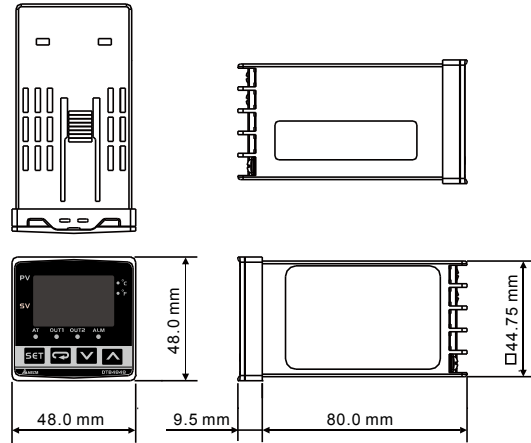

4896

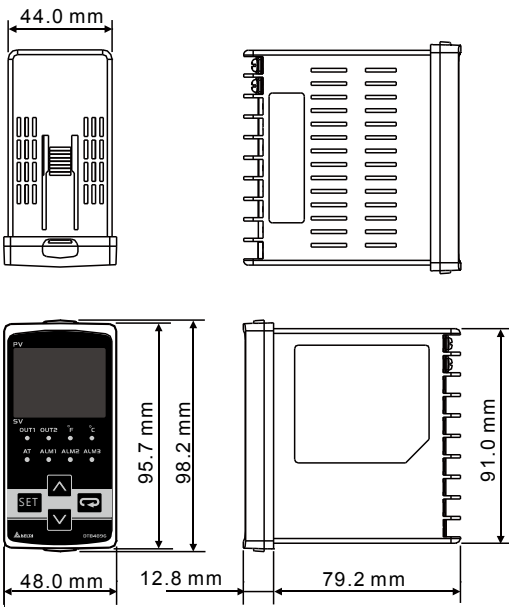

9696

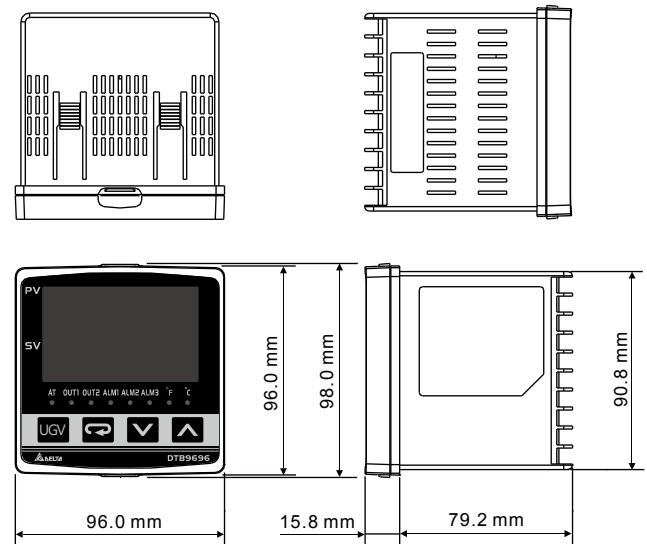

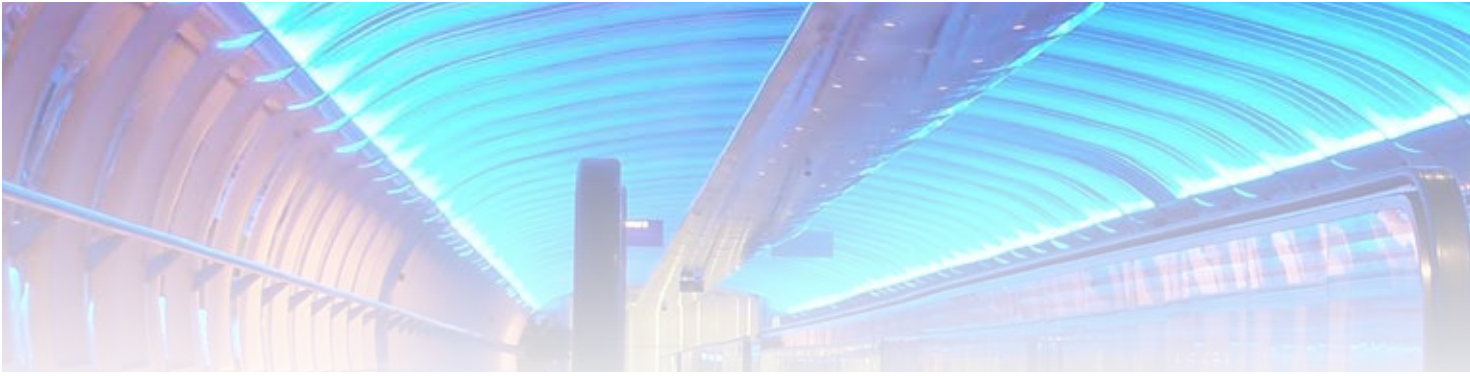

## DTA 7272

## 9648

Unit: mm

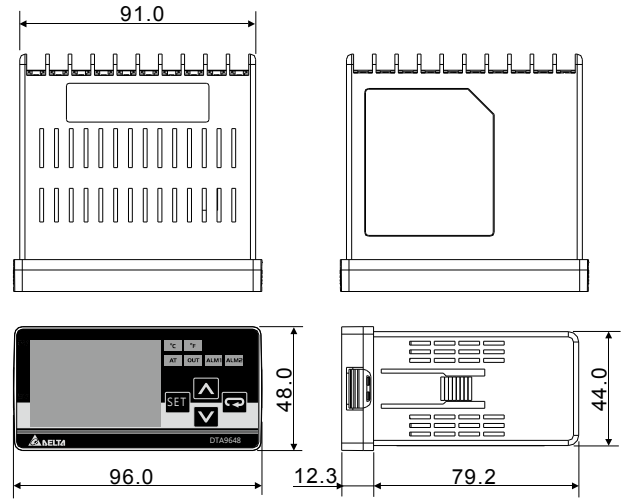
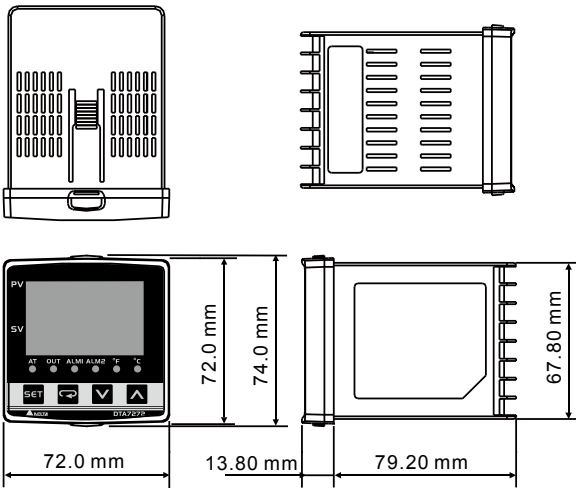

## DTC

## DTE

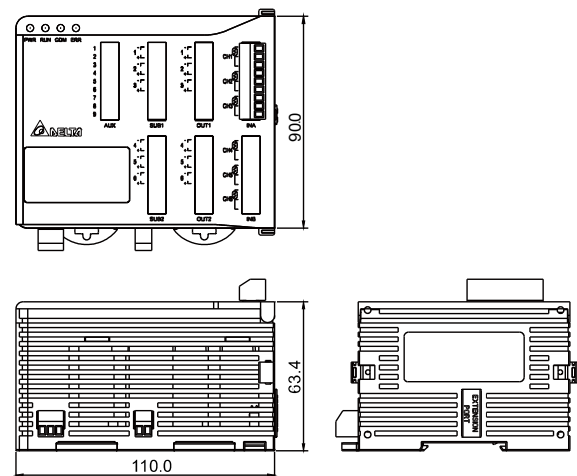
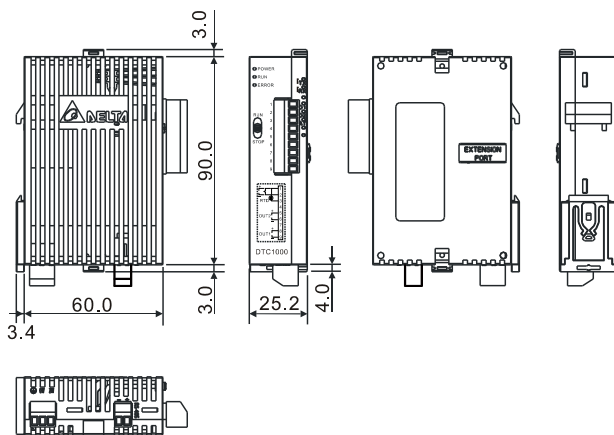





## DT3

320

330

CT30A

Unit: mm

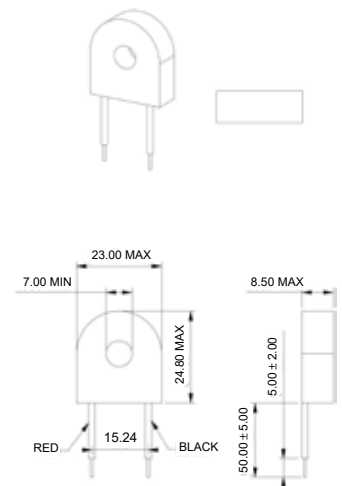
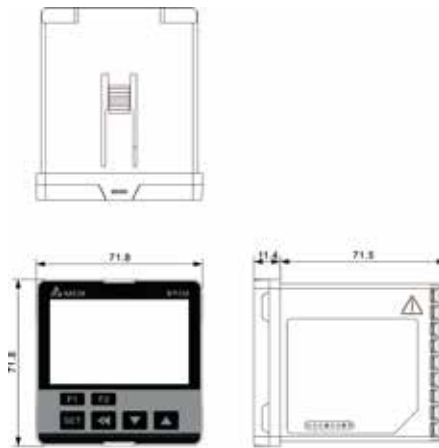
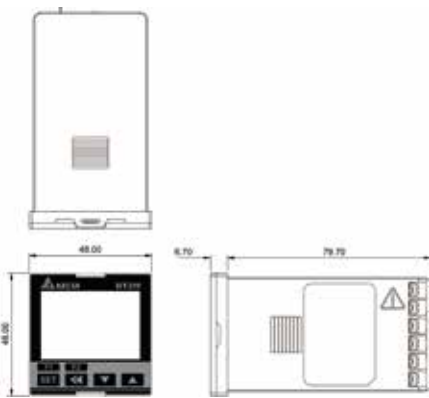

340

360

CT100A

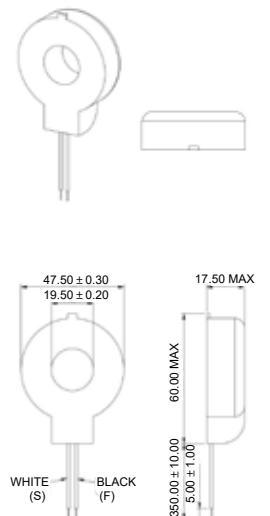
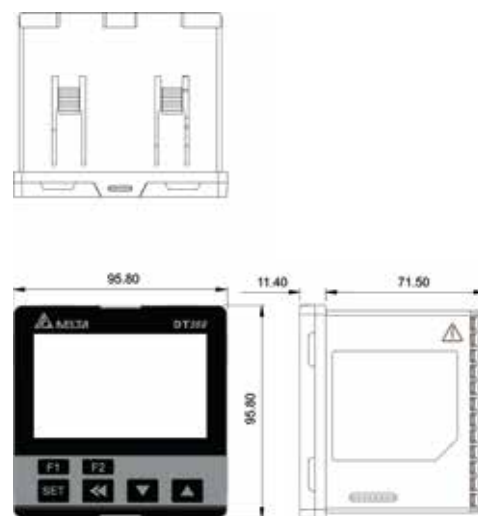
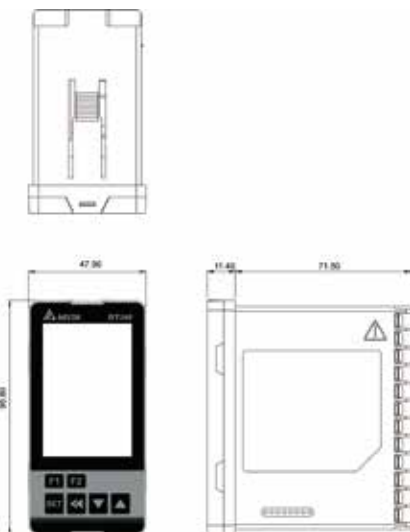

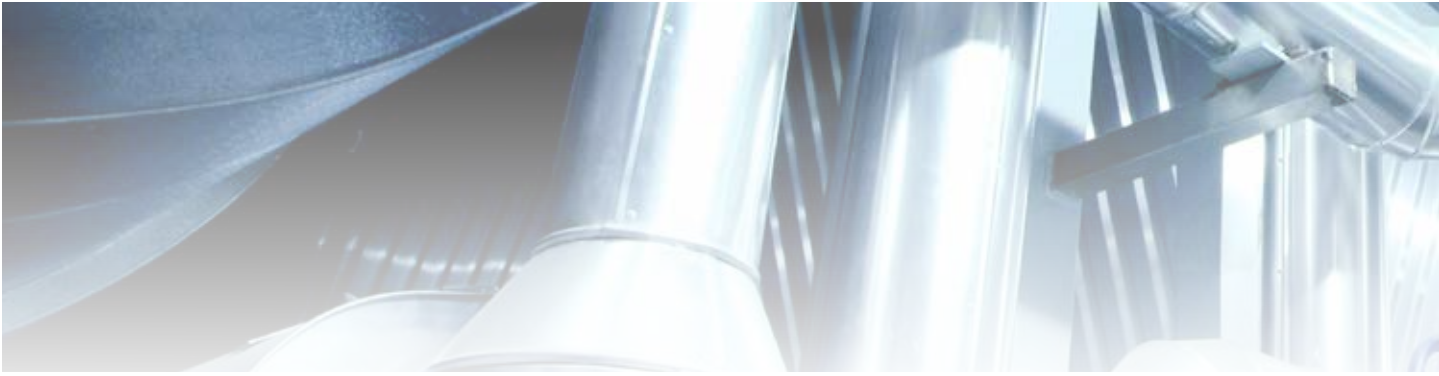

# DTK

4848

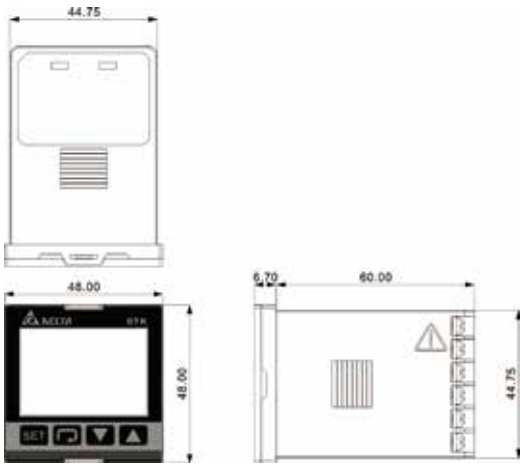

4896

Unit: mm

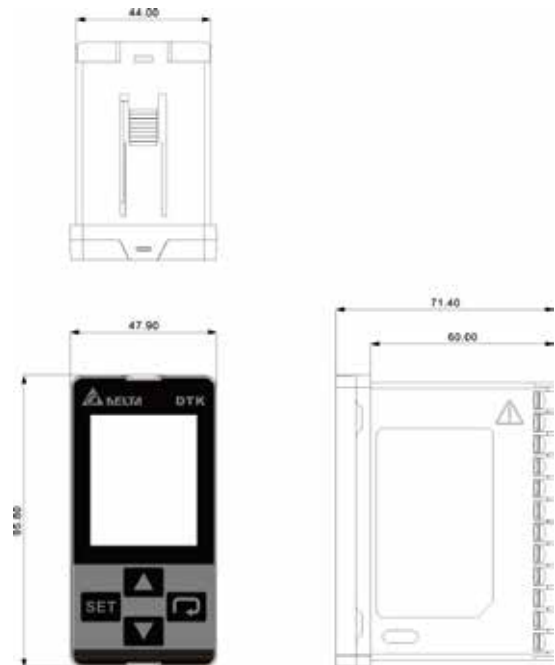

7272

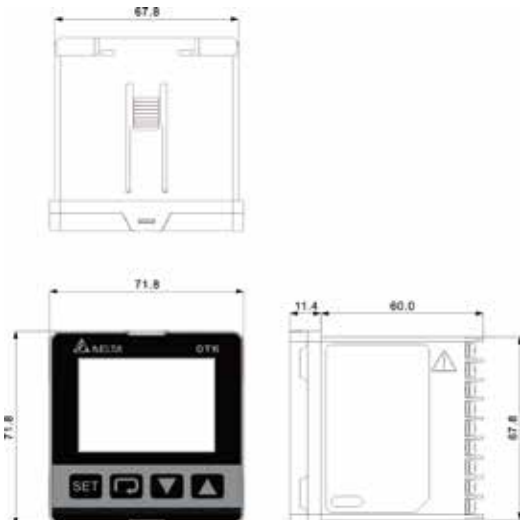

9696

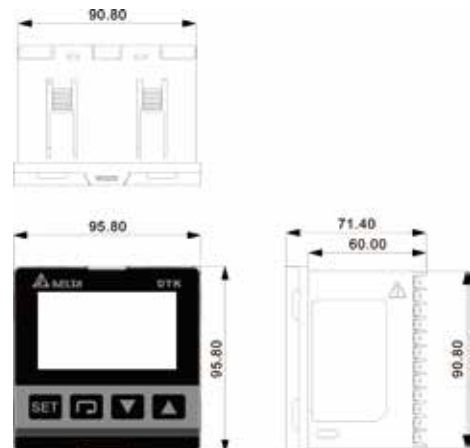





Smarter. Greener. Together.

## Industrial Automation Headquarters

### Delta Electronics, Inc.

Taoyuan Technology Center  
No.18, Xinglong Rd., Taoyuan District,  
Taoyuan City 33068, Taiwan  
TEL: 886-3-362-6301 / FAX: 886-3-371-6301

## Asia

### Delta Electronics (Shanghai) Co., Ltd.

No.182 Minyu Rd., Pudong Shanghai, P.R.C.  
Post code : 201209  
TEL: 86-21-6872-3988 / FAX: 86-21-6872-3996  
Customer Service: 400-820-9595

### Delta Electronics (Japan), Inc.

Tokyo Office  
Industrial Automation Sales Department  
2-1-14 Shibadaimon, Minato-ku  
Tokyo, Japan 105-0012  
TEL: 81-3-5733-1155 / FAX: 81-3-5733-1255

### Delta Electronics (Korea), Inc.

Seoul Office  
1511, 219, Gasan Digital 1-Ro., Geumcheon-gu,  
Seoul, 08501 South Korea  
TEL: 82-2-515-5305 / FAX: 82-2-515-5302

### Delta Energy Systems (Singapore) Pte Ltd.

4 Kaki Bukit Avenue 1, #05-04, Singapore 417939  
TEL: 65-6747-5155 / FAX: 65-6744-9228

### Delta Electronics (India) Pvt. Ltd.

Plot No.43, Sector 35, HSIIDC Gurgaon,  
PIN 122001, Haryana, India  
TEL: 91-124-4874900 / FAX : 91-124-4874945

### Delta Electronics (Thailand) PCL.

909 Soi 9, Moo 4, Bangpoo Industrial Estate (E.P.Z),  
Pattana 1 Rd., T.Phraksa, A.Muang,  
Samutprakarn 10280, Thailand  
TEL: 66-2709-2800 / FAX : 662-709-2827

### Delta Energy Systems (Australia) Pty Ltd.

Unit 20-21/45 Normanby Rd., Notting Hill Vic 3168, Australia  
TEL: 61-3-9543-3720

## Americas

### Delta Electronics (Americas) Ltd.

Raleigh Office  
P.O. Box 12173, 5101 Davis Drive,  
Research Triangle Park, NC 27709, U.S.A.  
TEL: 1-919-767-3813 / FAX: 1-919-767-3969

### Delta Greentech (Brasil) S/A

São Paulo Office  
Rua Itapeva, 26 – 3º Andar - Bela Vista  
CEP: 01332-000 – São Paulo – SP - Brasil  
TEL: 55-11-3530-8642 / 55-11-3530-8640

### Delta Electronics International Mexico S.A. de C.V.

Mexico Office  
Vía Dr. Gustavo Baz No. 2160, Colonia La Loma,  
54060 Tlalnepantla Estado de Mexico  
TEL: 52-55-2628-3015 #3050/3052

## EMEA

### Headquarters: Delta Electronics (Netherlands) B.V.

Sales: Sales.IA.EMEA@deltaww.com  
Marketing: Marketing.IA.EMEA@deltaww.com  
Technical Support: iatechnicalsupport@deltaww.com  
Customer Support: Customer-Support@deltaww.com  
Service: Service.IA.emea@deltaww.com  
TEL: +31(0)40 800 3800

### BENELUX: Delta Electronics (Netherlands) B.V.

De Witbogt 20, 5652 AG Eindhoven, The Netherlands  
Mail: Sales.IA.Benelux@deltaww.com  
TEL: +31(0)40 800 3800

### DACH: Delta Electronics (Netherlands) B.V.

Coesterweg 45, D-59494 Soest, Germany  
Mail: Sales.IA.DACH@deltaww.com  
TEL: +49(0)2921 987 0

### France: Delta Electronics (France) S.A.

ZI du bois Challand 2, 15 rue des Pyrénées,  
Lisses, 91090 Evry Cedex, France  
Mail: Sales.IA.FR@deltaww.com  
TEL: +33(0)1 69 77 82 60

### Iberia: Delta Electronics Solutions (Spain) S.L.U

Ctra. De Villaverde a Vallecas, 265 1º Dcha Ed.  
Hormigueras – P.I. de Vallecas 28031 Madrid  
TEL: +34(0)91 223 74 20

Carrer Llacuna 166, 08018 Barcelona, Spain

Mail: Sales.IA.Iberia@deltaww.com

### Italy: Delta Electronics (Italy) S.r.l.

Ufficio di Milano Via Senigallia 18/2 20161 Milano (MI)  
Piazza Grazioli 18 00186 Roma Italy  
Mail: Sales.IA.Italy@deltaww.com  
TEL: +39 02 64672538

### Russia: Delta Energy System LLC

Vereyskaya Plaza II, office 112 Vereyskaya str.  
17 121357 Moscow Russia  
Mail: Sales.IA.RU@deltaww.com  
TEL: +7 495 644 3240

### Turkey: Delta Greentech Elektronik San. Ltd. Sti. (Turkey)

Şerifaii Mah. Hendem Cad. Kule Sok. No:16-A  
34775 Ümraniye – İstanbul  
Mail: Sales.IA.Turkey@deltaww.com  
TEL: + 90 216 499 9910

### GCC: Delta Energy Systems AG (Dubai BR)

P.O. Box 185668, Gate 7, 3rd Floor, Hamarain Centre  
Dubai, United Arab Emirates  
Mail: Sales.IA.MEA@deltaww.com  
TEL: +971(0)4 2690148

### Egypt + North Africa: Delta Electronics

511 Cairo Business Plaza, North 90 street,  
New Cairo, Cairo, Egypt  
Mail: Sales.IA.MEA@deltaww.com